



Wiring Accessories

About CBI-electric: low voltage

CBI-electric: low voltage is a South African company with more than half a century of experience in the design and manufacture of a comprehensive range of technically advanced products for electrical protection.

It is the combination of experience and innovation with which we have maintained our position as leader in the marketplace - from the world's first high sensitivity RCD, and the use of hydraulic-magnetic technology in residential and industrial applications, to the more recently launched compact and technologically QAI7 earth leakage.

In addition to our comprehensive product offering, CBI offers a range of wiring accessories, perfect for complementing the interior design of any home or office. The three ranges available are as follows:

- Plastic (available in White and Silver Shimmer)
- Metal (White)
- Brushed Stainless Steel

The ranges are aesthetically pleasing and have flexible designs for ease of installation. One of the novel features of the Plastic and Metal ranges is a fluorescent green insert that serves as a useful indicator light in a dark room. This characteristic is indicative of the contemporary design of the ranges, which successfully marries functionality with aesthetics.

In addition, to ensure easy integration into existing offices and homes, the range is compatible with commonly used base plates and housings.

Our commitment to safety and quality is evident in the fact that our ranges hold SABS approvals, approved to:

- SANS 164-0
- SANS / IEC 60669-1
- SANS / IEC 60950
- SANS 164-1
- SANS / IEC 60884-1
- VC 8003
- SANS 164-2
- SANS / IEC 60947-3
- VC8008



Plastic Range Wiring Accessories



Fluorescent Insert



Features

- Unique fluorescent insert
- Easy to install
- Variety of inserts available
- Ease of operation
- Convenient removal and replacement of surround

Technical Specifications

- Voltage: 250 V AC
- Current rating: 16 A

Light Switches (2 x 4 - 250 V AC, 16 A, IP20)



L120-P/ L121-P



L122-P/ L123-P



L124-P



L125-P

Product Code	Product Description	Product Code	Product Description
L120-P	1 Lever 1 Way Light Switch White	L120C03-T	1 Lever 1 Way Light Switch Silver Shimmer
L121-P	1 Lever 2 Way Light Switch White	L121C03-T	1 Lever 2 Way Light Switch Silver Shimmer
L122-P	2 Lever 1 Way Light Switch White	L122C03-T	2 Lever 1 Way Light Switch Silver Shimmer
L123-P	2 Lever 2 Way Light Switch White	L123C03-T	2 Lever 2 Way Light Switch Silver Shimmer
L124-P	3 Lever 1 Way Light Switch White	L124C03-T	3 Lever 1 Way Light Switch Silver Shimmer
L125-P	4 Lever 1 Way Light Switch White	L125C03-T	4 Lever 1 Way Light Switch Silver Shimmer

Plastic Range Wiring Accessories
Light Switches (4 x 4 - 250 V AC, 16 A, IP20)

L126-P

L127-P

Product Code	Product Description	Product Code	Product Description
L126-P	4 Lever 1 Way Light Switch White	L126C03-T	4 Lever 1 Way Light Switch Silver Shimmer
L127-P	6 Lever 1 Way Light Switch White	L127C03-T	4 Lever 1 Way Light Switch Silver Shimmer

Blanking / Grid Plates

G000-P

G001-P

G002-P

G003-P

G009-P

S013-P

Product Code	Product Description	Product Code	Product Description
G000-P	Grid Plate 1LVR White	G000C03-T	Grid Plate 1LVR Silver Shimmer
G001-P	Grid Plate 2LVR White	G001C03-T	Grid Plate 2LVR Silver Shimmer
G002-P	Grid Plate 3LVR White	G002C03-T	Grid Plate 3LVR Silver Shimmer
G003-P	Grid Plate 4LVR White	G003C03-T	Grid Plate 4LVR Silver Shimmer
G009-P	Grid Plate Blank White	G009C03-T	Grid Plate Silver Shimmer
S013-P		Surround	

Blanking / Grid Plates

G004-P

G005-P

S014R-P

G010-P

Product Code	Product Description	Product Code	Product Description
G004-P			Grid Plate 1LVR White
G005-P			Grid Plate 2LVR White
S014R-P			Surround 2 Piece Top & Bot
G010-P	Grid Plate Blank White	G010C03-T	Blank Silver Shimmer

Plastic Range Wiring Accessories

Switched Socket Outlets (2 x 4 - 250 V AC, 16 A, IP20)



PS672-P



PS673-P



PS681-P

Product Code	Product Description	Product Code	Product Description
PS672-P	Single Switched Socket Outlet Vertical Standard White	PS672C03-T	Single Socket Outlet Silver Shimmer
PS673-P	Single Switched Socket Outlet Standard Horizontal White	PS673C03-T	Single Socket Outlet Horizontal Silver Shimmer
PS681-P	SA/EU combined Socket Outlet Vertical White	PS681C03-T	SA/EU combined Socket Outlet Vertical Silver Shimmer

Switched Socket Outlets (4 x 4 - 250 V AC, 16 A, IP20)



PS674R-P



PS675R-P



PS680-P



PS682R-P



PS683R-P



PS685USB-P

Product Code	Product Description	Product Code	Product Description
PS674R-P	Single Switched Socket Outlet White	PS674C03-T	Single Switched Socket Outlet Silver Shimmer
PS675R-P	Double Switched Socket Outlet White	PS675C03-T	Double Switched Socket Outlet Silver Shimmer
PS680-P	SA/EU combined Switched Socket Outlet White	PS680C03-T	SA/EU combined Switched Socket Outlet Silver Shimmer
PS682R-P	6 Way Euro Socket Outlet		
PS683R-P	Single Switched Socket Outlet with 3 x 5 A Euro Sockets		
PS685USB-P	USB / SA / Euro Switched Socket Outlet		

Unswitched Socket Outlets (250 V AC, 6 A, IP20)



PS679-P

Product Code	Product Description
PS679-P	Unswitched Socket Outlet Round White

Plastic Range Wiring Accessories

Dedicated Switched Socket Outlets (4 x 4 - 250 V AC, 16 A, IP20)

PS676R-P

PS677R-P

Product Code	Product Description
PS676R-P	Single Switched Dedicated Socket Outlet Red
PS677R-P	Double Switched Dedicated Socket Outlet Red

Surface Mount Outlet Boxes

OB690

OB878

Product Code	Product Description
OB690	Surface Mount 2 X 4 Outlet Box (Plastic)
OB878	Surface Mount 4 X 4 Outlet Box (Plastic)

Switch Disconnectors (4 x 4 - 2 and 3 Pole, 250 V AC, 60 A, IP20)

I129-P / I131-P

Product Code	Product Description	Product Code	Product Description
I129-P	Stove Isolator 2P White	I129C03-T	Stove Isolator 2P Silver Shimmer
I131-P	Stove Isolator 3P White	I131C03-T	Stove Isolator 3P Silver Shimmer

Plastic Range Wiring Accessories

Switch Disconnecter (2 x 4 - 2 Pole, 250 V AC, 30 A, IP20)



I130-P

Product Code	Product Description	Product Code	Product Description
I130-P	Geyser Isolator 2P White	I130C03-T	Geyser Isolator 2P Silver Shimmer

TV & Telephone Socket Outlets and Bell Push (2 x 4 - 250 V AC, 16 A, IP20)



TV678-P



B133-P



T686-P

Product Code	Product Description	Product Code	Product Description
TV678-P	Single TV Socket Outlet White	TV678C03-T	Single TV Socket Outlet Silver Shimmer
B133-P	Bell Push Socket Outlet White	B133C03-T	Bell Push Socket Outlet Silver Shimmer
T686-P	Single Telephone Socket Outlet (RJ11) White	T686C03-T	Single Telephone Socket Outlet (RJ11) Silver Shimmer

Neon, TV, DSTV and Telephone Inserts



I1662-P



T1657-P



TVI663-P



TVI664-P



DI645-P

Product Code	Product Description	Product Code	Product Description
I1662-P	Indication Light Insert Red		
T1657-P	Telephone Socket Insert RJ11 White	T1657C03-T	Telephone Socket Insert RJ11 Silver Shimmer
TVI663-P	Standard TV Connection Insert	TVI663C03-T	Standard TV Connection Insert Silver Shimmer
TVI664-P	DSTV Connection Insert	TVI664C03-T	DSTV Connection Insert Silver Shimmer
DI645-P	Data Socket Insert (RJ45)		

Plastic Range Wiring Accessories

Switch Inserts (IP20)



LI659-P



LI660-P



LI661-P



LI662-P



LI663-P / II663-P



BI661-P

Product Code	Product Description	Product Code	Product Description
LI659-P	Light Switch Insert 1 Way 16 A White	LI659C03-T	Switch Insert 1 Way Silver Shimmer
LI660-P	Light Switch Insert 2 Way 16 A White	LI660C03-T	Switch Insert 2 Way Silver Shimmer
LI661-P	Dimmer Switch Insert 16 A White	LI661C03-T	Dimmer Switch Insert 16 A Silver Shimmer
LI662-P	Blank Switch Insert White	LI662C03-T	Blank Switch Insert Silver Shimmer
LI663-P	2P Switch Insert 16 A White	-	-
II663-P	2P Switch Insert 20 A White	II663C03-T	2P Switch Insert 20 A Silver Shimmer
LI664-P	Intermediate Switch Insert 16 A White	LI664C03-T	Intermediate Switch Insert 16 A Silver Shimmer
BI661-P	Bell Push Insert 4 A White	BI661C03-T	Bell Push Insert 4 A Silver Shimmer

Switch Advantage Colour Option - Silver Shimmer

The plastic range is also available in Silver Shimmer.



Plastic Range Grid Plate Selection Guide

Switch to Flexibility...

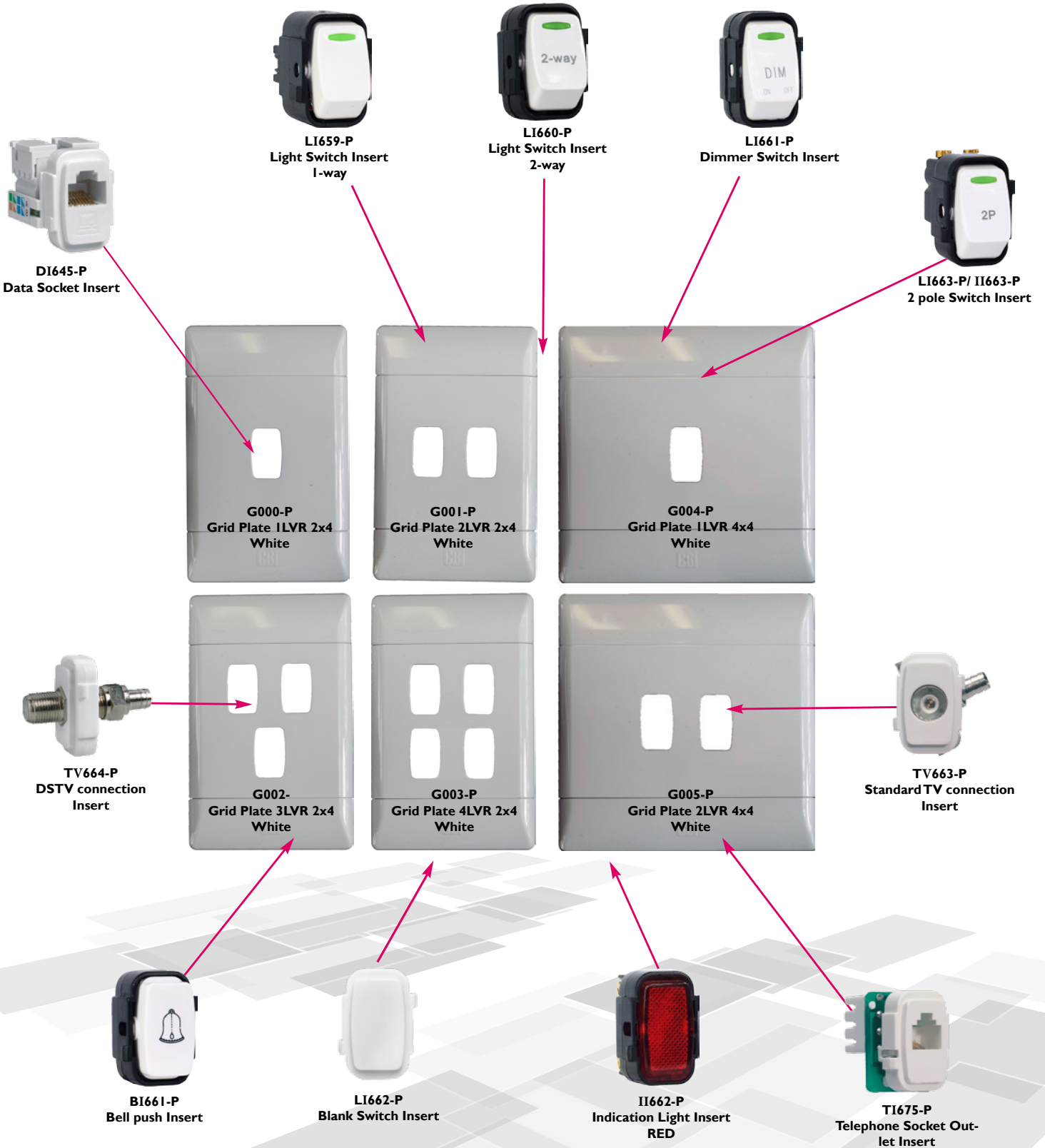

Metal White Range Wiring Accessories



**Metal
Cover Plate**



Features

- Metal Cover Plates
- Aesthetically pleasing
- Screwless cover plates
- SA/ Euro Socket Outlet combo

Technical Specifications

- Voltage: 250 V AC
- Current rating: 16 A

Light Switches (2 x 4 - 250 V AC, 16 A, IP20)



L120-M/ L121-M



L122-M/ L123-M



L124-M



L125-M

Product Code	Product Description
L120-M	1 Lever 1 Way Light Switch Metal White
L121-M	1 Lever 2 Way Light Switch Metal White
L122-M	2 Lever 1 Way Light Switch Metal White
L123-M	2 Lever 2 Way Light Switch Metal White
L124-M	3 Lever 1 Way Light Switch Metal White
L125-M	4 Lever 1 Way Light Switch Metal White

Metal White Range Wiring Accessories

Blanking / Grid Plates



G000-M



G001-M



G002-M



G003-M

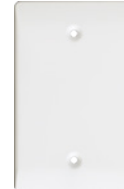

G009-M



G010-M

Product Code	Product Description
G000-M	Front Plate 1L 2 x 4 Metal White
G001-M	Front Plate 2L 2 x 4 Metal White
G002-M	Front Plate 3L 2 x 4 Metal White
G003-M	Front Plate 4L 2 x 4 Metal White
G009-M	Blanking Plate 2 x 4 Metal White
G010-M	Blanking Plate 4 x 4 Metal White

Switched Socket Outlets (2 x 4 - 250V AC, 16 A, IP20)



PS673-M



PS684-M

Product Code	Product Description
PS673-M	Single Switched Socket Outlet Horizontal Metal White
PS684-M	Single Dedicated Switched Socket Outlet Horizontal Metal Red

Switched Socket Outlets (4 x 4 - 250V AC, 16 A, IP20)



PS674-M



PS675-M

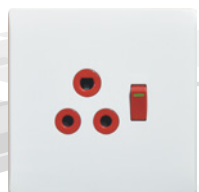

PS676-M



PS677-M



PS680-M

Product Code	Product Description
PS674-M	Single Switched Socket Outlet Metal White
PS675-M	Double Switched Socket Outlet Metal White
PS676-M	Single Switched Dedicated Socket Outlet Metal Red
PS677-M	Double Switched Dedicated Socket Outlet Metal Red
PS680-M	SA/EU combined Switched Socket Outlet Metal White

Metal White Range Wiring Accessories

Switch Disconnectors (4 x 4 - 2 and 3 Pole, 250 V AC, 60 A, IP20)



1129-M/ 1131-M

Product Code	Product Description
1129-M	Stove Isolator 2P Metal White
1131-M	Stove Isolator 3P Metal White

Switch Disconnector (2 x 4 - 2 Pole, 250 V AC, 30 A, IP20)



1130-M

Product Code	Product Description
1130-M	Geyser Isolator 2P Metal White

Metal Range Grid Plate Selection Guide

Switch to Flexibility...



Brushed Stainless Steel Range Wiring Accessories

**Screwless
Cover Plate**
Features

- Aesthetically pleasing
- Standard 2 way Switch
- Screwless base plates
- SA/ 3pin Euro Socket Outlet combo

Technical Specifications

- Voltage: 250 VAC
- Current rating: 16 A

Light Switches (2 x 4 - 250 V AC, 16 A, IP20)

VIS/JOS42/SSGINT

VIS/JOS42/SS1G2W

VIS/JOS42/SS2G2W

VIS/JOS42/SS3G2W

VIS/JOS42/SS4G2W

Product Code	Product Description
VIS/JOS42/SSGINT	1G Intermediate Switch
VIS/JOS42/SS1G2W	1G 2 Way Light Switch
VIS/JOS42/SS2G2W	2G 2 Way Light Switch
VIS/JOS42/SS3G2W	3G 2 Way Light Switch
VIS/JOS42/SS4G2W	4G 2 Way Light Switch

Brushed Stainless Steel Range Wiring Accessories

Blanking / Grid Plates



VIS/JOS42/SSBP

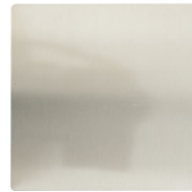

VIS/JOS44/SSBLANK

Product Code	Product Description
VIS/JOS42/SSBP	Blanking Plate 2x4
VIS/JOS44/SSBLANK	Blanking Plate 4x4

Switched Socket Outlets (4 x 4 - 250 V AC, 16 A, IP20)

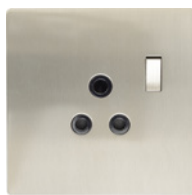

VIS/JOS44/SSSSS



VIS/JOS44/SSDSS



VIS/JOS44/SSSSES

Product Code	Product Description
VIS/JOS44/SSSSS	Single Switched Socket Outlet
VIS/JOS44/SSDSS	Double Switched Socket Outlet
VIS/JOS44/SSSSES	Switched Socket + Euro Socket Outlet

Switch Disconnectors (4 x 4 - 2 and 3 Pole, 250 V AC, 60 A, IP20)



VIS/JOS44/SSSS60A3P

Product Code	Product Description
VIS/JOS44/SSSS60A3P	Stove Isolator 60 A 3 Pole Switch

Brushed Stainless Steel Range Wiring Accessories

TV, Telephone Socket Outlets and Bell Push (2 x 4 - 250 V AC, 16 A, IP20)



VIS/JOS42/SSDBS



VIS/JOS44/SSTVSAT



VIS/JOS44/SSRJ11/44

Product Code	Product Description
VIS/JOS42/SSDBS	Bell Switch (4 x 2)
VIS/JOS44/SSRJ11/44	RJ11 Phone Socket + RJ45 Internet Socket (4 x 4)
VIS/JOS44/SSTVSAT	TV & Satellite Outlet (4 x 4)

Inserts



VIS/JOS42/SSDIM

Product Code	Product Description
VIS/JOS42/SSDIM	Bell Switch Module Metal Rocker

Wiring Accessories

Outline Dimensions: Dual mount

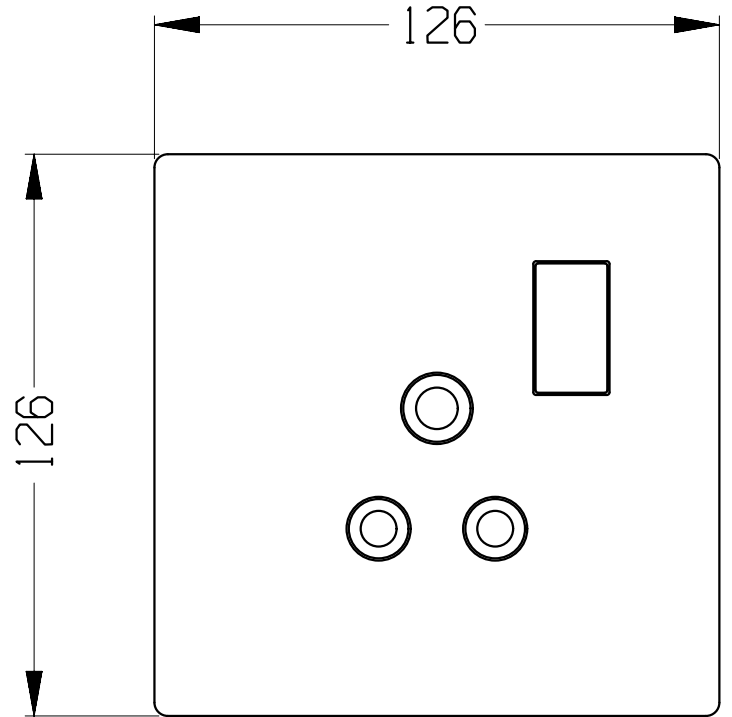
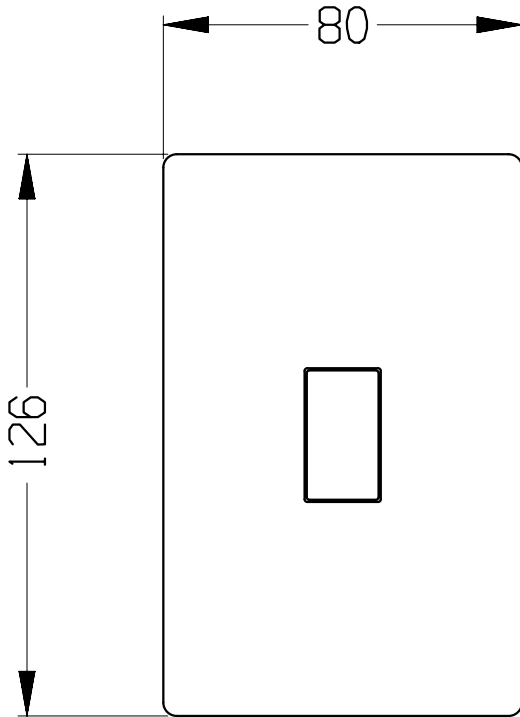

D500LED-P Dimmer Trailing Edge



Features

- Improved functionality
- Now compatible with incandescent and halogen lamps
- The CBI D500LED-P Dimmer is also compatible with the following dimmable LED lights:
 - Aurora
 - EcoLED
 - NVC
 - Osram
 - Philips
 - Radiant
- *For specific lamp specifications and more compatible brands, please contact CBI*
- Press switch once for ON or OFF operations
- Press and hold switch to dim to required level
- Silent operation
- Short circuit, thermal & overload protection
- Two-way & intermediate switching is possible without using an additional strapper wire

Pre-settings

- Press switch 2x to activate 50% Energy Saving Setting (E.S.S)
- Press switch 5x (Security Setting) - this will result in an automatic random change in the lights intensity
- To reset for normal use, press switch once

Power Interruption

When power is restored after a Power Interruption, the lights will:

Remain OFF if they were off

or

Switch ON automatically at 50% E.S.S. if they were on prior to interruption

Technical Specifications

Operation:

- Press dimmer (bell-press) switch once to turn on or off
- Press and hold switch to dim up or down, release switch at desired light level

Memory:

- Lights will turn on to the same level as when it was turned off if power is not interrupted
- After a power failure: if lights were off, it will remain off
- After a power failure: if the lights were on, it will revert to 50% intensity to conserve energy

Installation:

- By a qualified electrician in compliance with local code of practice
- Wire according to wiring diagram (NEVER connect white control wires to live)
- Only one dimmer per wall box
- Internal use only
- Two way switching: connect the two white wires to other switch (NO live strapper)

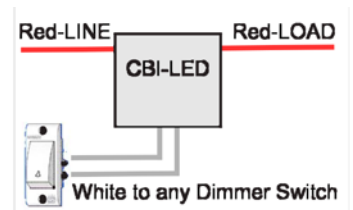

D500LED-P Dimmer Trailing Edge

Load compatibility and maximum ratings:

	Dimming Method	Wire Wound & Inductive Loads	230 V AC, Resistive & Electronic low voltage	230 V AC & 12 V LED **	Fluorescent & CFL	230 V AC Incandescent & Halogen
D500LED-P	Trailing	NOT Compatible	500 VA, 2.1 A max	500 VA, 2.1 A max	NOT Compatible	500 VA

* Min. load = 3 - 10 W (depending on type of load). Max load = (Dimmer VA rating) x (Load power factor)

** Only compatible with low voltage dimmable LED lamps with approved electronic transformers

CBI LED dimmers are compatible with incandescent and halogen lamps, as well as LED lamps from major LED suppliers: Osram, Philips, Samsung, Verbatim, Aurora, GE. Check with LED lamp suppliers for compatibility if uncertain.

One year carry-in warranty. Standard terms and conditions apply. Warranty void if seal is broken.



Patent: 2007/4502, SANS 60669-2-1, EN 61046, EN 61047, ISO 9001:2008 (KIWA)

Designed and manufactured in South Africa



Technical Data

Product Type	D500LED-P	
Operating Voltage Range	190 - 253 V AC, 50 Hz + 5%	
Compatible with Transformers Using:	Trailing and Leading Edge Technology	
Maximum Load Power @ 230 V AC:	500 W (2.1 A)	
- Electronic Transformer	500 W (2.1 A)	
Approvals	SANS	60669-2-1
RCC No.	0603019	
Dimensions (HxWxD)	42 mm x 42 mm x 13 mm	

500 W Universal Dimmer D500LED-P		
Load Tables	Minimum Load	Minimum Load
 12 V Low Voltage Electronic Transformer	3 W	500 W
 230 V AC Mains Incandescent Halogen		
 230 V AC Mains Incandescent LED Lamps		

* Not suitable for use with fluorescent or compact fluorescent lights

D500LED-P Dimmer Trailing Edge

Wiring diagrams

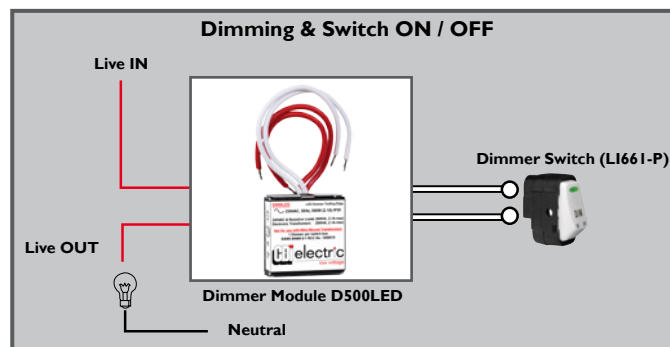
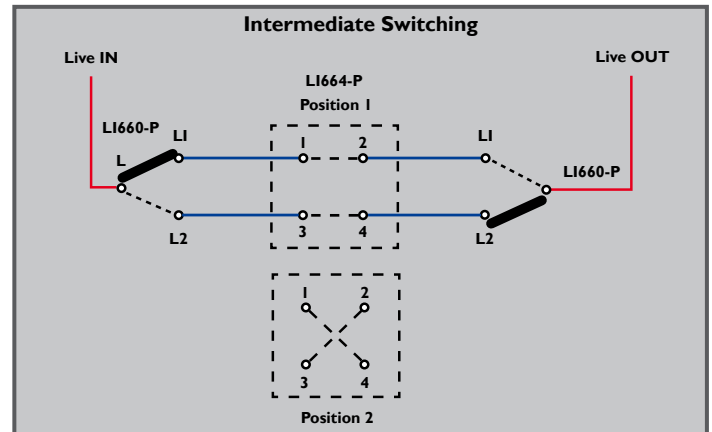
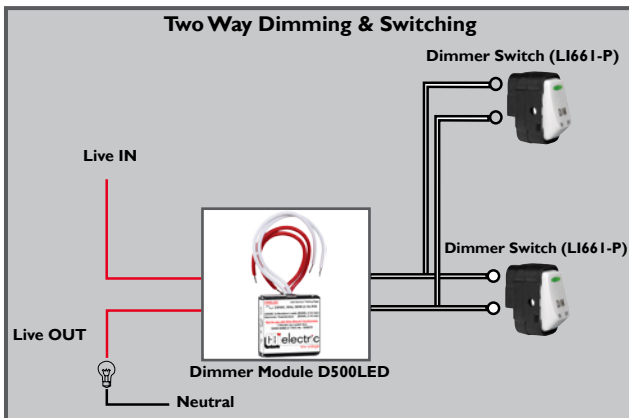
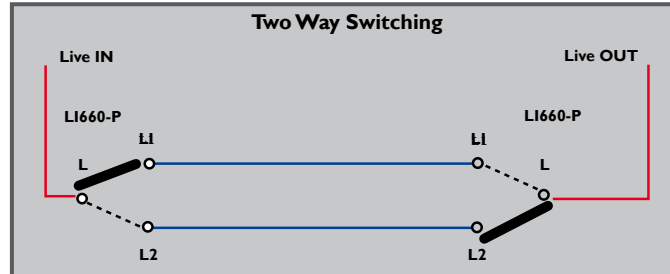

Please review our Customer Terms and Conditions on www.cbi-lowvoltage.co.za

All rights reserved. Unless otherwise indicated, all materials on these pages are copyrighted by CBI (Pty) Ltd. No part of these pages, either text or image may be used for any purpose other than personal use. Therefore, reproduction, modification, storage in a retrieval system or retransmission, in any form or by any means, electronic, mechanical or otherwise, for reasons other than personal use, is strictly prohibited without prior written permission. CBI (Pty) Ltd reserves the right to alter any details of this document without notice and while every effort is made to ensure the accuracy of the content, no warranty is given as to accuracy of this document and no responsibility will be accepted for error or misinterpretation and any resulting loss.

AUSTRALIA

CBI-electric: Australia
90 Fairbank Road Clayton South
Melbourne Victoria 3169 Australia
Tel: + 61 39590 3500
Fax: +61 3 9551 1051
Email: sales@cbi-electric.com.au
Website: www.cbi-electric.com.au

SOUTH AFRICA

CBI-electric: low voltage
Tripswitch Drive Elandsfontein
Gauteng South Africa
Tel: +27 11 928 2000
Fax: + 27 11 392 2354
Email: cbi@cbi-electric.com
Website: www.cbi-lowvoltage.co.za

USA

CBI-electric: North America
35 E. Uwchlan Ave Suite 328
Exton PA 19341 USA
Tel: +1 610 524 9949
Fax: +1 610 524 9945
E-mail: info@cbibreakers.com
Website: www.cbibreakers.com